

**Stainless Steel Air Bellows, Serviceable
Single Acting
Ø 8 to 14 1/2 inches**

- **High corrosion and acid resistant materials**
- **Frictionless operation**
- **No maintenance or lubrication**
- **Ideal for short stroke, high-force applications**
- **High isolation level for vibrating machines**
- **Very easy to install - no alignment problems**

Technical Data

Medium:

Compressed air, non-lubricated

Operation:

Single acting

Operating Pressure:

8 bar maximum

Operating Temperature

-40°C to + 70°C for KM/31000 (Standard)

-25°C to + 90°C for TKM/31000 (Butyl)

-20°C to + 115°C for EKM/31000 (Epichlore)

Nominal Diameters:

8, 10, 12, 14 1/2 inches

Stroke Lengths:

From 80 to 380 mm max., depending on diameters and number of convolutions

Materials:

End plates: Stainless Steel 1.4301 (AISI 304)

Fixing studs: Stainless Steel 1:4301 (AISI 304)

Central ring: Stainless Steel 1.4301 (AISI 304)

Rubber part: KM/31000 fabric reinforced NR-, SBR-,
BR- compound rubber

TKM/31000 fabric reinforced Butyl

EKM/31000 fabric reinforced Epichlore

Ordering Example

See page N 1.8.007.02

Important Instructions:

The design of these Air Bellows allows an operation at an angle of 5° to 25°. The top and bottom plate can be out of alignment, depending on the height of the Air Bellow and the number of convolutions. To avoid damage mechanical stops at both end positions have to be used. To return Air Bellows to their minimum height an external return force must be used. The thrust depends directly on the height of the Air Bellow: When height increases – the thrust decreases. As the outside diameter varies in operation there must be enough clearance around the Air Bellow.

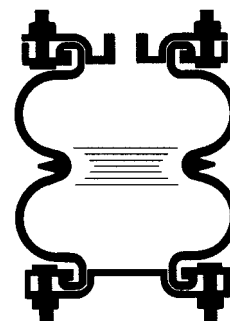
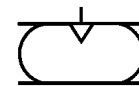



Air Bellow Variants

Symbol	Model	Description	Dimensions Page
	KM/31000	Standard rubber material Ø 8 to 14 1/2 inches	03
	TKM/31000	Butyl rubber material Ø 8 to 14 1/2 inches	03
	EKM/31000	Epichlore rubber material Ø 8 to 14 1/2 inches	03

Model Codes

KM/31**

Air Bellow Materials	Substitute
High temperature (Butyl)	T
Extreme temperature (Epichlore)	E

Metal Parts	Substitute
Stainless Steel	K

Threads	Substitute
Metric	Port: ISO 228 (BSP)

Series	Substitute
31000	

Number of Convolutions	Substitute
1	1
2	2
3	3

Nominal Diameters (inches)	Substitute
8	08
10	10
12	12
14 1/2	14

Note: Please fill in only the numbers of digits required e.g. KM/31101

Ordering Example

Stainless Steel Air Bellows, Serviceable

To order a Serviceable Stainless Steel Air Bellow in standard rubber material, a nominal diameter of 8 inches and 2 convolutions, quote: **KM/31082**

Warning

These products are intended for use in industrial compressed air systems only. Do not use these products where pressures and temperatures can exceed those listed under 'Technical Data'.

Before using these products with fluids other than those specified, for non-industrial applications, life-support systems, or other applications not within published specifications, consult NORGREN.

Through misuse, age, or malfunction, components used in fluid power systems can fail in various modes.

The system designer is warned to consider the failure modes of all component parts used in fluid power systems and to provide adequate safeguards to prevent personal injury or damage to equipment in the event of such failure.

System designers must provide a warning to end users in the system instructional manual if protection against a failure mode cannot be adequately provided.

System designers and end users are cautioned to review specific warnings found in instruction sheets packed and shipped with these products.



Basic Dimensions

KM/31081 to KM/31143

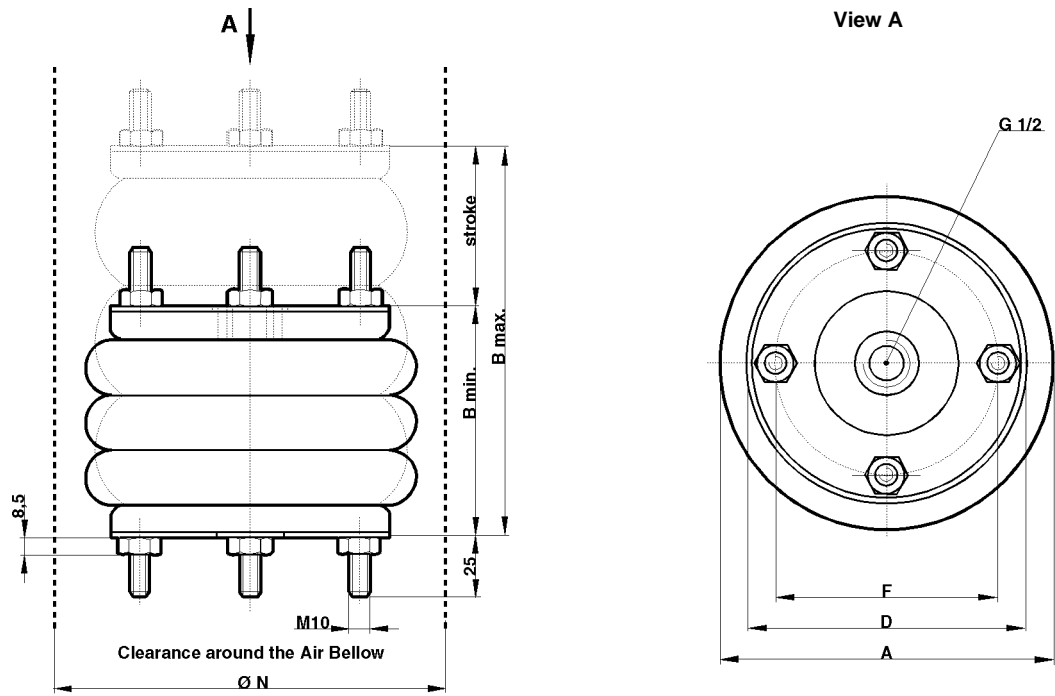

Table 1

Model	Nominal Ø (inches) x Convolutions	Stroke (mm)	Installation Height		Ø A	Ø D	Ø F	Ø N	Weight (kg)
			B min. (mm)	B max. (mm)					
KM/31081	8 x 1	80	50	130	230	184	155,5	245	6,4
KM/31082	8 x 2	175	75	250	220	184	155,5	245	7,3
KM/31101	10 x 1	100	50	150	280	210	181	300	8,5
KM/31102	10 x 2	225	75	300	270	210	181	300	9,7
KM/31103	10 x 3	330	100	430	270	210	181	300	10,9
KM/31121	12 x 1	100	50	150	330	260	232	350	13,2
KM/31122	12 x 2	225	75	300	325	260	232	350	14,8
KM/31123	12 x 3	330	100	430	325	260	232	350	16,3
KM/31141	14 1/2 x 1	125	50	175	395	310	282,5	425	18,6
KM/31142	14 1/2 x 2	265	75	340	400	310	282,5	425	19,6
KM/31143	14 1/2 x 3	380	100	480	400	310	282,5	425	20,5



Thrust (at 2, 4, 6, 8 bar), Volume (at 6 bar)

— Thrust (N) - - Volume (l)

KM/31081

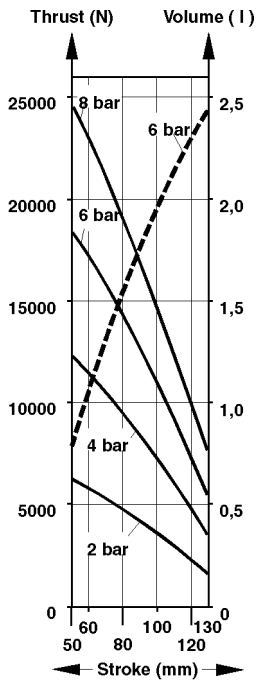

KM/31082

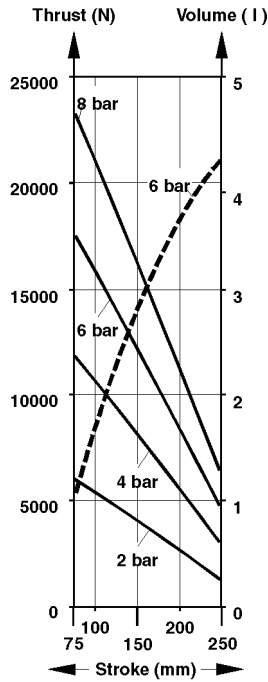

KM/31101

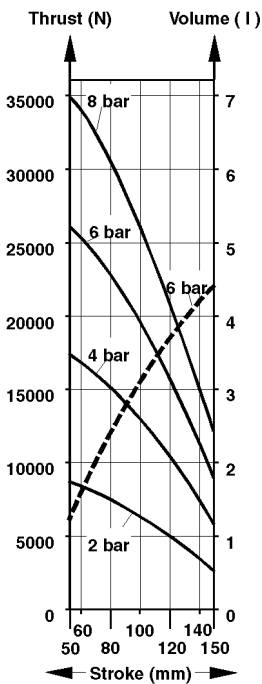

KM/31102

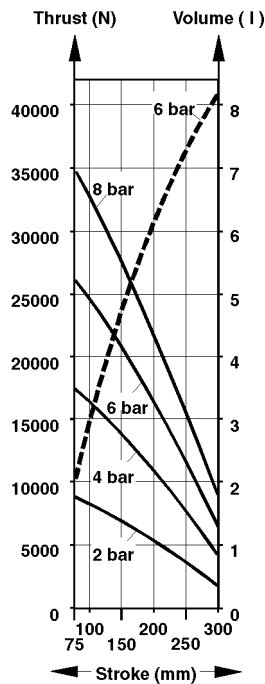

KM/31103

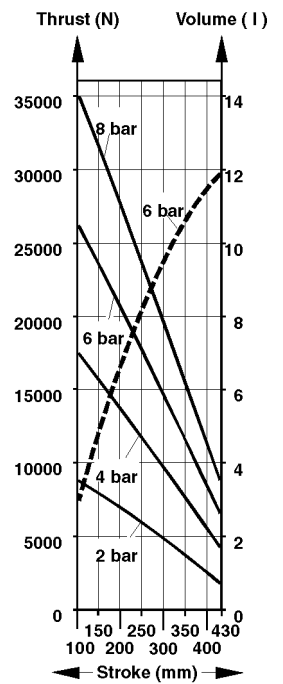



Thrust (at 2, 4, 6, 8 bar), Volume (at 6 bar)

— Thrust (N) -- Volume (l)

KM/31121

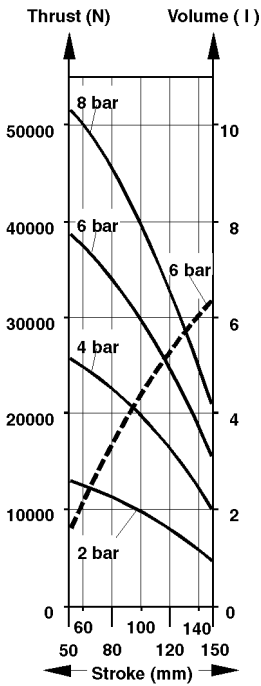

KM/31122

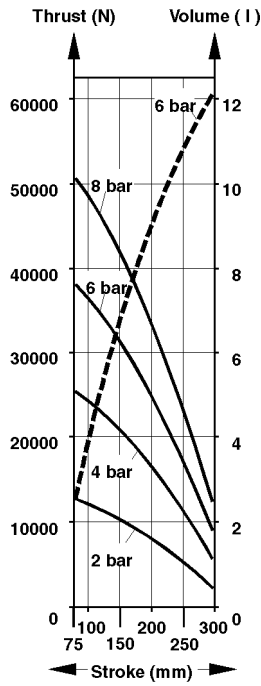

KM/31123

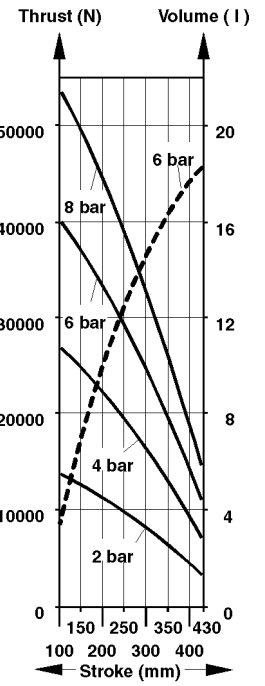

KM/31141

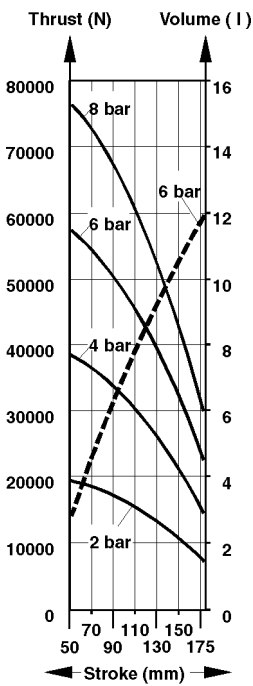

KM/31142

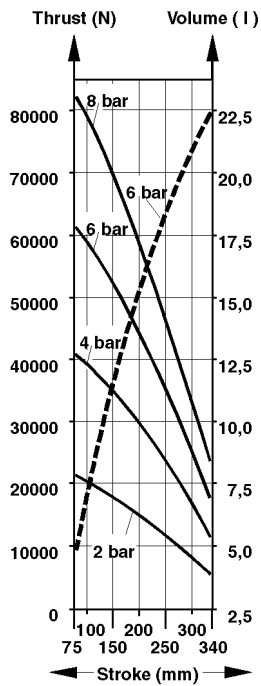

KM/31143

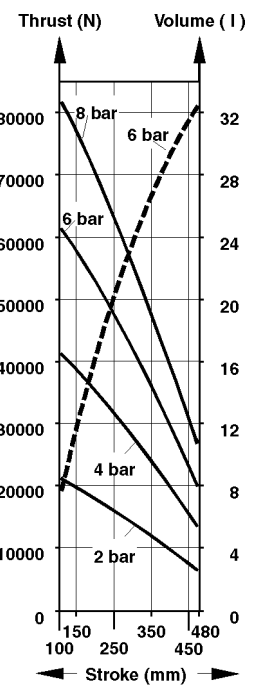



Calculation of Serviceable Stainless Steel Air Bellows used as ACTUATORS

Datasheet

- a) Total weight to be lifted: $F = \dots\dots\dots \text{ kg} \cdot 10 \text{ m/s}^2 = \dots\dots\dots \text{ [N]}$ f) Vertical space: $X_v = \dots\dots\dots \text{ [mm]}$
 b) Number of Air Bellows: $n = \dots\dots\dots$ g) Horizontal space: $X_h = \dots\dots\dots \text{ [mm]}$
 c) Thrust per Air Bellow: $f = \frac{F}{n} = \dots\dots\dots = \dots\dots\dots \text{ [N]}$ h) Operating temperature: $T = \dots\dots\dots \text{ [}^\circ\text{C]}$
 d) Operating pressure: $P = \dots\dots\dots \text{ [bar]}$ i) Operation angle $\alpha = \dots\dots\dots \text{ [}^\circ\text{]}$
 e) Required stroke $S = \dots\dots\dots \text{ [mm]}$ j) Out of alignment $A = \dots\dots\dots \text{ [mm]}$
 k) Chemical resistance $\dots\dots\dots$

Important Instructions

- Thrust:** The thrust depends on the height of the bellow. When height increases – the thrust decreases.
Stops: To avoid damage when the bellow is compressed or extended mechanical stops at both end positions have to be used.
Clearance: There must be enough clearance around the Air Bellow.

Table 2: Thrust, Vibration Height, Retracting Force

Model	Nominal Ø (inches) x Convolutions	Stroke (mm)	Installation Height B min. (mm)	Thrust at 6 bar (N)	Retracting Force to Reach min. Height (N)	Installation Height B max. (mm)	Thrust at 6 bar (N)
KM/31081	8 x 1	80	50	18600	120	130	5350
KM/31082	8 x 2	175	75	17700	130	250	4550
KM/31101	10 x 1	100	50	26500	100	150	9000
KM/31102	10 x 2	225	75	26350	100	300	6450
KM/31103	10 x 3	330	100	26600	110	430	6500
KM/31121	12 x 1	100	50	39000	90	150	15000
KM/31122	12 x 2	225	75	38500	90	300	8550
KM/31123	12 x 3	330	100	40600	100	430	10900
KM/31141	14 1/2 x 1	125	50	57600	80	175	21550
KM/31142	14 1/2 x 2	265	75	62000	80	340	16900
KM/31143	14 1/2 x 3	380	100	62550	290	480	19200

Operation Angle

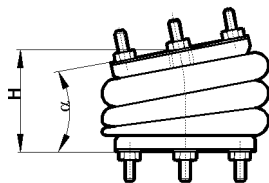

Out of Alignment

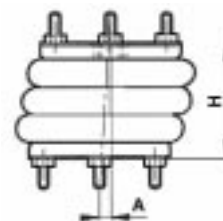

Table 3

Model	Nominal Ø (inches) x Convolutions	Range of Height H (mm) when					Range of Height H (mm) when				
		$\alpha=5^\circ$	$\alpha=10^\circ$	$\alpha=15^\circ$	$\alpha=20^\circ$	$\alpha=25^\circ$	A=10 mm	A=20 mm	A=30 mm	A=40 mm	A=50 mm
KM/31081	8 x 1	60-105	70-100	—	—	—	65-115	70-95	—	—	—
KM/31082	8 x 2	—	90-210	100-205	110-200	115-190	95-230	95-220	115-210	130-195	—
KM/31101	10 x 1	60-125	70-115	80-105	—	—	70-135	80-130	90-115	—	—
KM/31102	10 x 2	—	95-260	115-250	135-245	155-235	105-280	125-275	145-265	170-250	—
KM/31103	10 x 3	185-390	245-370	280-350	—	—	165-390	200-380	220-365	230-350	240-345
KM/31121	12 x 1	60-125	75-115	90-105	—	—	70-135	80-130	90-115	—	—
KM/31122	12 x 2	—	100-255	110-245	115-235	160-225	105-270	130-260	150-245	175-230	—
KM/31123	12 x 3	200-375	230-340	250-310	—	—	150-400	175-385	195-375	215-360	235-345
KM/31141	14 1/2 x 1	65-145	85-135	—	—	—	85-160	95-145	105-125	—	—
KM/31142	14 1/2 x 2	—	105-300	115-290	135-275	170-260	120-330	140-320	165-315	185-305	—
KM/31143	14 1/2 x 3	280-430	300-390	310-370	—	—	180-450	205-440	225-425	245-410	260-385



Example for Selecting Serviceable Stainless Steel Air Bellows used as ACTUATORS

A 1000 kg conveyor carrying a 550 kg pallet needs to be lifted by 80 mm (stroke) in order to transfer the pallet to another level. Four (4) Air Bellows should be used. The available operating pressure is 5 bar. The operating temperature is 60°C. There is a 270 mm square space to house each Air Bellow. Compression and extension stops are provided. The Air Bellows have to be mounted between in a space which are 85 mm apart. During the lifting operation the conveyor may tilt in the second half of the stroke by a max. of 9°.

Step 1: Fill in and complete the Datasheet:

- | | |
|--|---|
| a) $F = (1000 \text{ kg} + 550 \text{ kg}) \cdot 10 \text{ m/s}^2 = 15500 \text{ N}$ | g) $X_h = 270 \text{ mm}$ |
| b) $n = 4$ | h) $T = 60^\circ\text{C}$ |
| c) $f = \frac{F}{n} = \frac{15500 \text{ N}}{4} = 3875 \text{ N}$ | i) $\alpha = 9^\circ$ |
| d) $P = 5 \text{ bar}$ | j) $A = 0 \text{ mm}$ |
| e) $S = 80 \text{ mm}$ | k) Chemical resistance: |
| f) $X_v = 85 \text{ mm}$ | Metal parts: non-corrosive materials |
| | Rubber body: normal environment (Standard material) |

Step 2: From table 1 (catalogue sheet N 1.8.007.03) Air Bellows have to be selected that have a min. 80 mm stroke and a clearance around the Air Bellows smaller than $X_h = 270 \text{ mm}$

We select: KM/31081 and KM/31082

Step 3: Calculate the total height at which the Air Bellow should be used, see step 1:

Vertical space	X_v	85 mm
Stroke	S	80 mm
Total height		165 mm

By referring to the total height of 165 mm and the vertical space of 85 mm, only KM/31082 (installation height 75 to 250mm) can be used from table 1 (catalogue sheet N 1.8.007.03)

Step 4: Check the thrust at 6 bar at a height of 165 mm.

From the charts in the catalogue sheet N 1.8.007.04 we can see that

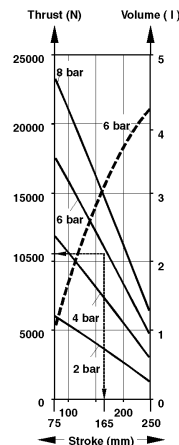

KM/31082 will provide 10500 N at 6 bar.

To get the figure for 5 bar, we have to calculate:

$$\frac{10500 \text{ N} \cdot 5}{6} = 8750 \text{ N at 5 bar}$$

Conclusion: The Air Bellow KM/31082 can provide the required thrust of 3875 N.

Step 5: Check the angle acceptance when the Air Bellow can tilt during the second half of the stroke between 125 and 165 mm by approx. 10° from table 3 (catalogue sheet N 1.8.007.06). At 9° we are well within the limits.

- i) KM/31082 can sustain an angle of 9° between 95 and 260 mm
KM/31082 can be used in this application

Step 6: Check all remaining parameters

- h) At 60°C Standard rubber material (-40° to +70°C) can be used
j) No horizontal mis-alignment
k) This Air Bellow can be used for applications in the food industry

Result: KM/31082 is the chosen Serviceable Stainless Steel Air Bellow, because it meets all requirements.



Calculation of Serviceable Stainless Steel Air Bellows used as VIBRATION ISOLATORS

Datasheet

- a) Total weight to be isolated: $F = \dots\dots\dots \text{ kg} \cdot 10 \text{ m/s}^2 = \dots\dots\dots \text{ [N]}$ g) Operating temperature: $T = \dots\dots\dots \text{ [}^\circ\text{C]}$
 b) Number of Air Bellows: $n = \dots\dots\dots$ h) Chemical resistance: $\dots\dots\dots$
 c) Thrust per Air Bellow: $f = \frac{F}{n} = \dots\dots\dots = \dots\dots\dots \text{ [N]}$ i) Isolation rate: $I = \dots\dots\dots \text{ [%]}$
 d) Operating pressure: $P = \dots\dots\dots \text{ [bar]}$ j) Airspring natural frequency: $f_n = \dots\dots\dots \text{ [Hz]}$
 e) Vertical space: $X_v = \dots\dots\dots \text{ [mm]}$ k) Excitation frequency: $f_e = \dots\dots\dots \text{ [Hz]}$
 f) Horizontal space: $X_h = \dots\dots\dots \text{ [mm]}$

Important Instructions

- Air Bellows with two convolutions will provide better isolation because of the greater volume of air in comparison to Air Bellows with one convolution.
- Air Bellows used for vibration isolation should be operated at a »vibration height«. This height is the result of tests and represents the optimum height where the Air Bellow gives the best performance. The airspring natural frequency (f_n) remains nearly constant at the »vibration height«. An increase of the height will result in less isolation, a lower height may influence the horizontal (lateral) stability.
- The optimum pressure for vibration isolation is from 4 to 6 bar (60 to 90 psi)
- The lower the airspring natural frequency (f_n) of an Air Bellow the better the vibration isolation.
- The lateral stability of Air Bellows decreases with the number of convolutions.
It is important to note: **Air Bellows with 3 convolutions should not be used without consulting Norgren.**
- Ideally Air Bellows should be located at the same horizontal plane (at the same height) as the centre of gravity of the machine in order to be vibration isolated
- For the purpose of calculation the following assumptions have been made:
 1. Vibrations are all vertical
 2. The excitation frequency (f_e) varies along a sine curve
 3. The object and its base are rigid

Table 4: Pressure, Vibration Height, Thrust, Volume, Stiffness, Airspring Natural Frequency, Isolation Rate

Model	Nominal Ø (inches) x Convolutions	Pressure (bar)	Vibration Height (mm)	Thrust (N)	Volume (l)	Stiffness (N/cm)	Airspring Natural Frequency f_n (Hz)	Isolation Rate I (%) at 10 Hz and 6 bar
KM/31081	8 x 1	4	100	7250	1,90	2379	2,86	91,1
		6	100	1105	1,96	3421	2,77	91,6
KM/31082	8 x 2	4	200	5450	3,54	882	2,00	95,8
		6	200	8400	3,66	1281	1,95	96,0
KM/31101	10 x 1	4	120	10450	3,53	2710	2,54	93,1
		6	120	15800	3,69	3850	2,46	93,5
KM/31102	10 x 2	4	220	9600	6,44	1254	1,80	96,6
		6	220	14550	6,67	1788	1,75	96,8
KM/31121	12 x 1	4	120	16250	5,12	4130	2,51	93,3
		6	120	24550	5,28	5880	2,44	93,7
KM/31122	12 x 2	4	220	14650	9,52	2000	1,84	96,5
		6	220	22250	9,85	2850	1,78	96,7
KM/31141	14 1/4 x 1	4	130	26250	8,97	5590	2,30	94,4
		6	130	39400	9,28	7840	2,22	94,8
KM/31142	14 1/4 x 2	4	250	23800	17,8	2640	1,66	97,2
		6	250	35600	18,4	3730	1,61	97,3

Values for Air Bellows with 3 convolutions are not given as they cannot be used as vibration isolators.



Example for Selecting Serviceable Stainless Steel Air Bellows used as VIBRATION ISOLATORS

A hydraulic power unit with an excitation frequency (f_e) between 1200 and 3000 cycles/min (= 20 Hz to 50 Hz) must be vibration isolated. The total weight of the power unit is 6000 kg. The supporting area under the unit is 1.2 m x 0.8 m. The operating temperature is 50°C. The space for the installation is 220 mm high. Four Air Bellows will be used. The max. operating pressure is 6 bar. A minimum of 97% vibration isolation has to be reached.

Step 1: Fill in and complete the Datasheet:

- | | | | |
|-------------------|---|---|--------------------------------------|
| a) F | = 6000 kg • 10 m/s ² = 60000 N | h) Chemical resistance: | |
| b) n | = 4 | Metal parts: non-corrosive materials | |
| c) f | = $\frac{F}{n} = \frac{60000 \text{ N}}{4} = 15000 \text{ N}$ | Rubber body: normal environment (Standard material) | |
| d) P | = 6 bar | i) I | = 97% |
| e) X _v | = 220 mm | j) f _n | = select from table 4 |
| f) X _h | = 400 mm | k) f _e min. | = 20 Hz, f _e max. = 50 Hz |
| g) T | = 50°C | | |

Three types of Air Bellows are chosen. Each one has to carry 15000 N at the vibration height. From table 4 (catalogue sheet N 1.8.007.08) we select:

1. KM/31101 – 15800 N at 6 bar – 2.46 Hz airspring natural frequency (f_n)
2. KM/31121 – 16250 N at 4 bar – 2.51 Hz airspring natural frequency (f_n)
3. KM/31122 – 22250 N at 6 bar – 1.78 Hz airspring natural frequency (f_n)

Step 2: Take the Air Bellow with the lowest airspring natural frequency f_n = 1,78 Hz in order to get the highest isolation rate referring to f_e min. = 20 Hz. Air Bellow KM/31122 is chosen.

Step 3: Calculate the isolation rate (I) of the KM/31122 by using the formula:

Formula

$$I = 1 - \frac{1}{\left(\frac{f_e}{f_n}\right)^2 - 1}$$

Example

$$I = 1 - \frac{1}{\left(\frac{20}{1,78}\right)^2 - 1} = 1 - \frac{1}{125,2} = 0,992$$

$$I = 99,2\%$$

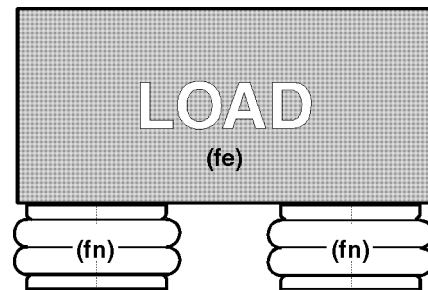

f_e = Excitation frequency of the load
f_n = Airspring natural frequency

Step 4: Check all remaining parameters

- The installation height of the Air Bellow KM/31122 is between B min.= 75 mm and B max.= 300 mm (table 1). The vertical space for installation is 220 mm. The 'vibration height' at which the Air Bellows operate best is 220 mm (table 4).
- The clearance around the Air Bellows. The horizontal space for installation is 400 mm for each Air Bellow. The clearance around the Air Bellow is 350 mm (table 1).
- At 50°C Standard rubber material (−40° to +70°) can be used
- Non-corrosive material is required
- Isolation rate at 10 Hz and 6 bar is 96,7% (table 4). At 20 Hz and 6 bar I= 99,2% is reached.

Result: 4 x KM/31122 Serviceable Stainless Steel Air Bellows are chosen. They will provide 99.2% vibration isolation