

In-Line, Non-Return Valves
M5, 1/8", 1/2"
BSPP, BSPT, NPT

- Permit free flow of air in one direction only
- Simple, reliable design
- Light weight
- Silicone free
- Low cracking pressure



Technical Data

Medium:

Compressed air, filtered, lubricated and non-lubricated

Operation:

Non-return valve

Mounting:

Line mounted

Port Sizes:

Metric	BSPP	BSPT	NPT
M5 T55M0500	G ¹ / ₈ T55C1800	Rc ¹ / ₈ T55B1800	1/8 NPT T55A1800
	G ¹ / ₄ T55C2800	Rc ¹ / ₄ T55B2800	1/4 NPT T55A2800
	G ³ / ₈ T55C3800	Rc ³ / ₈ T55B3800	3/8 NPT T55A3800
	G ¹ / ₂ T55C4800	Rc ¹ / ₂ T55B4800	1/2 NPT T55A4800

Operating Pressure:

0.1 - 10 bar

Operating Temperature:

-20°C* to +80°C

*Consult our Technical Service for use below +2°C

Materials

Aluminium body, silicone free nitrile rubber 'O' ring, POM valve, stainless steel spring

Ordering Information

To order, quote model number from table overleaf.

e.g. T55C2800 for the G¹/₄ model

Alternative Models

T50 Series In-line push-in non-return valves see page 5.10.002

T56 Series In-line male-female non-return valves.

T5/520 Series Heavy Duty non-return valves.

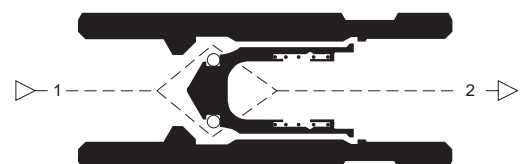
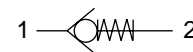



General Information

Model				Port size	Free Flow Flow factor		Cracking Pressure (bar)	Weight (gs)
Metric	BSPP	BSPT	NPT		C*	Cv**		
T55M0500				M5	0.8	0.19	0.05	10
	T55C1800	T55B1800	T55A1800	1/8"	2.4	0.59	0.05	15
	T55C2800	T55B2800	T55A2800	1/4"	5.5	1.35	0.05	25
	T55C3800	T55B3800	T55A3800	3/8"	9.0	2.20	0.05	60
	T55C4800	T55B4800	T55A4800	1/2"	15.0	3.70	0.05	80

C* : measured in $dm^3/(s.bar)$

Cv** : measured in US gall/min

Non-return Valve

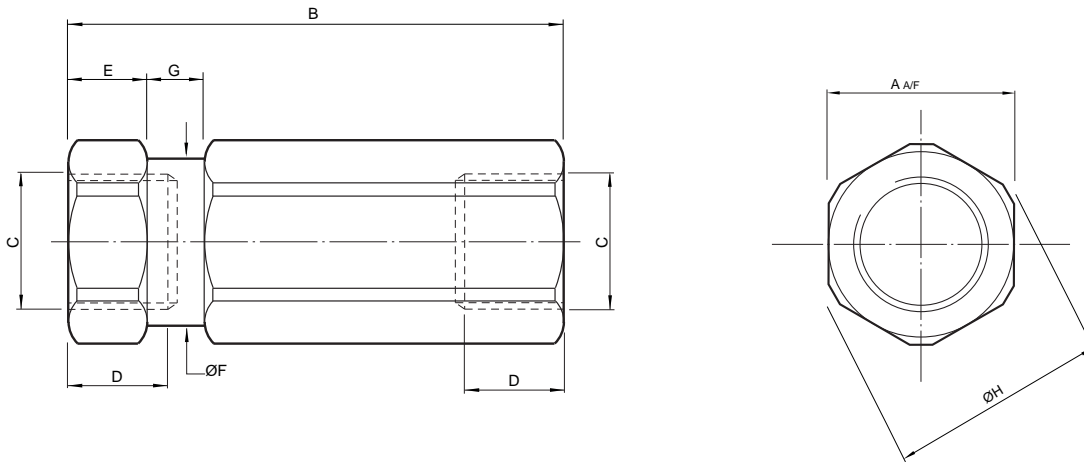

Model	T55M0500	T55A1800	T55B1800	T55C1800	T55A2800	T55B2800	T55C2800	T55A3800	T55B3800	T55C3800	T55A4800	T55B4800	T55C4800
A	11	14	14	14	17	17	17	24	24	24	27	27	27
B	27.5	42.5	42.5	42.5	54	54	54	63	63	63	77	77	77
C	M5	1/8	1/8	1/8	1/4	1/4	1/4	3/8	3/8	3/8	1/2	1/2	1/2
D	5	-	-	7	-	-	10.5	-	-	12	-	-	15
E	4	7	7	7	8	8	8	9	9	9	12	12	12
F	10.7	13.7	13.7	13.7	16.7	16.7	16.7	23.7	23.7	23.7	26.7	26.7	26.7
G	3	4	4	4	5	5	5	7	7	7	10	10	10
H	12	15	15	15	18.5	18.5	18.5	26	26	26	30	30	30

Warning

These products are intended for use in industrial compressed air systems only. Do not use these products where *pressures* and *temperatures* can exceed those listed under 'Technical Data'.

Before using these products with fluids other than those specified, for non-industrial applications, life-support systems, or other applications not within published specifications, consult Norgren.

Through misuse, age, or malfunction, components used in fluid power systems can fail in various modes. The system designer is warned to consider the failure modes of all component parts used in fluid power systems and to provide adequate safeguards to prevent personal injury or damage to equipment in the event of such failure.

System designers must provide a warning to end users in the system instructional manual if protection against a failure mode cannot be adequately provided.

System designers and end users are cautioned to review specific warnings found in instruction sheets packed and shipped with these products where applicable.

- Permit free flow of air in one direction only
- Simple, reliable design
- Male/Female connections
- Silicone free
- Low cracking pressure
- O ring in the parallel threads



Technical Data

Medium:

Compressed air, filtered, lubricated and non-lubricated

Operation:

Non-return valve

Mounting:

Line mounted

Port Sizes:

Metric	BSPP	BSPT	NPT
M5 T56M0500	1/8 T56C1800 1/4 T56C2800	1/8 T56B1800 1/4 T56B2800	1/8 T56A1800 1/4 T56A2800

Operating Pressure:

0.1 - 10 bar

Operating Temperature:

-20°C* to +80°C

*Consult our Technical Service for use below +2°C

Materials

Brass body, silicone free nitrile rubber 'O' ring, POM valve.

Ordering Information

To order, quote model number from table overleaf.

e.g. T56C2800 for the 1/4 BSPP model.

Alternative Models

T50 Series In-line push-in non-return valves see page 5.10.002

T55 Series Female Female In-line non-return valves.

T5/520 Series Heavy Duty non-return valves.

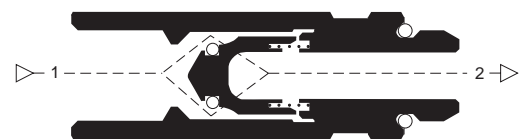
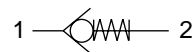



General Information

Model				Port size	Free Flow Flow factor		Cracking Pressure (bar)	Weight (gs)
Metric	BSPP	BSPT	NPT		C*	Cv**		
T56M0500				M5	0.55	0.19	0.05	18
	T56C1800	T56B1800	T56A1800	1/8"	2.4	0.59	0.05	45
	T56C2800	T56B2800	T56A2800	1/4"	5.0	1.23	0.05	80

C* : measured in dm³/(s.bar)

Cv** : measured in US gall/min

Non-return Valve

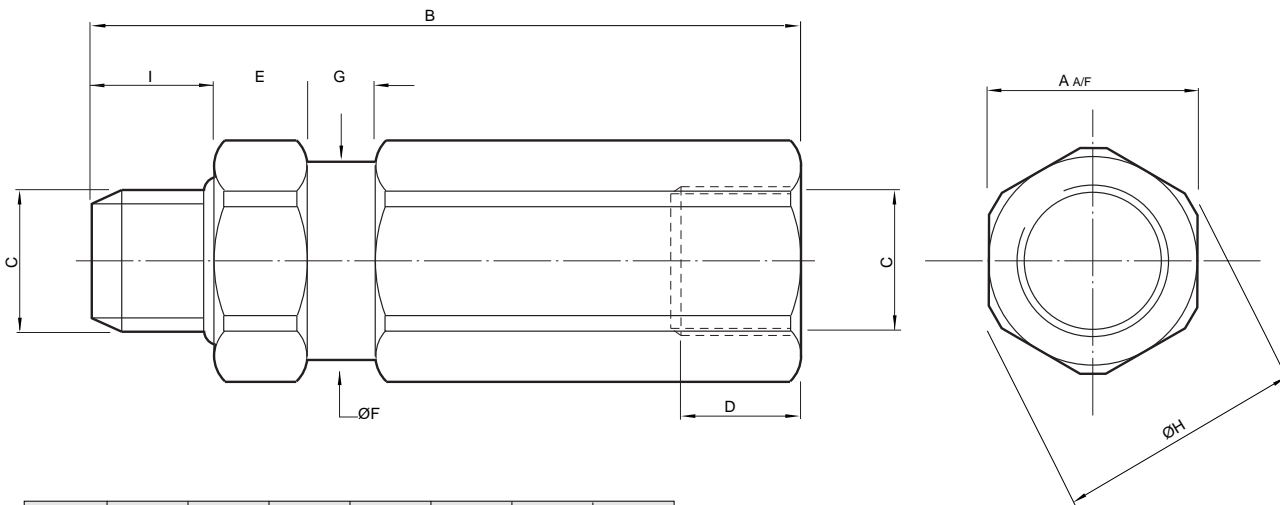

Model	T56M0500	T56A1800	T56B1800	T56C1800	T56A2800	T56B2800	T56C2800
A	11	14	14	14	17	17	17
B	31.8	49	49	45	62.5	59	56.2
C	M5	1/8	1/8	1/8	1/4	1/4	1/4
D	5	-	-	7	-	-	10.5
E	4	4.5	4.5	4.5	5.2	5.2	5.2
F	10.7	13.7	13.7	13.7	16.7	16.7	16.7
G	3	4	4	4	5	5	5
H	12	15	15	15	18.5	18.5	18.5
I	4.3	9.5	9.5	5.5	14.3	11	8

Warning

These products are intended for use in industrial compressed air systems only. Do not use these products where *pressures* and *temperatures* can exceed those listed under 'Technical Data'.

Before using these products with fluids other than those specified, for non-industrial applications, life-support systems, or other applications not within published specifications, consult Norgren.

Through misuse, age, or malfunction, components used in fluid power systems can fail in various modes. The system designer is warned to consider the failure modes of all component parts used in fluid power systems and to provide adequate safeguards to prevent personal injury or damage to equipment in the event of such failure.

System designers must provide a warning to end users in the system instructional manual if protection against a failure mode cannot be adequately provided.

System designers and end users are cautioned to review specific warnings found in instruction sheets packed and shipped with these products where applicable.

- Permit free flow of air in one direction only
- Simple, reliable design
- Male/Female connections
- Silicone free
- Low cracking pressure
- O ring in the parallel threads



Technical Data

Medium:

Compressed air, filtered, lubricated and non-lubricated

Operation:

Non-return valve

Mounting:

Line mounted

Port Sizes:

Metric	BSPP	BSPT	NPT
M5 T56M0500	1/8 T56C1800	1/8 T56B1800	1/8 T56A1800
	1/4 T56C2800	1/4 T56B2800	1/4 T56A2800

Operating Pressure:

0.1 - 10 bar

Operating Temperature:

-20°C* to +80°C

*Consult our Technical Service for use below +2°C

Materials

Brass body, silicone free nitrile rubber 'O' ring, POM valve.

Ordering Information

To order, quote model number from table overleaf.

e.g. T56C2800 for the 1/4 BSPP model.

Alternative Models

T50 Series In-line push-in non-return valves see page 5.10.002

T55 Series Female Female In-line non-return valves.

T5/520 Series Heavy Duty non-return valves.

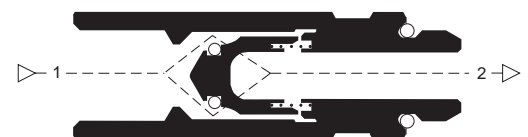
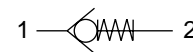



General Information

Model				Port size	Free Flow Flow factor		Cracking Pressure (bar)	Weight (gs)
Metric	BSPP	BSPT	NPT		C*	Cv**		
T56M0500				M5	0.55	0.19	0.05	18
	T56C1800	T56B1800	T56A1800	1/8"	2.4	0.59	0.05	45

C* : measured in dm³/(s.bar)

Cv** : measured in US gall/min

Non-return Valve

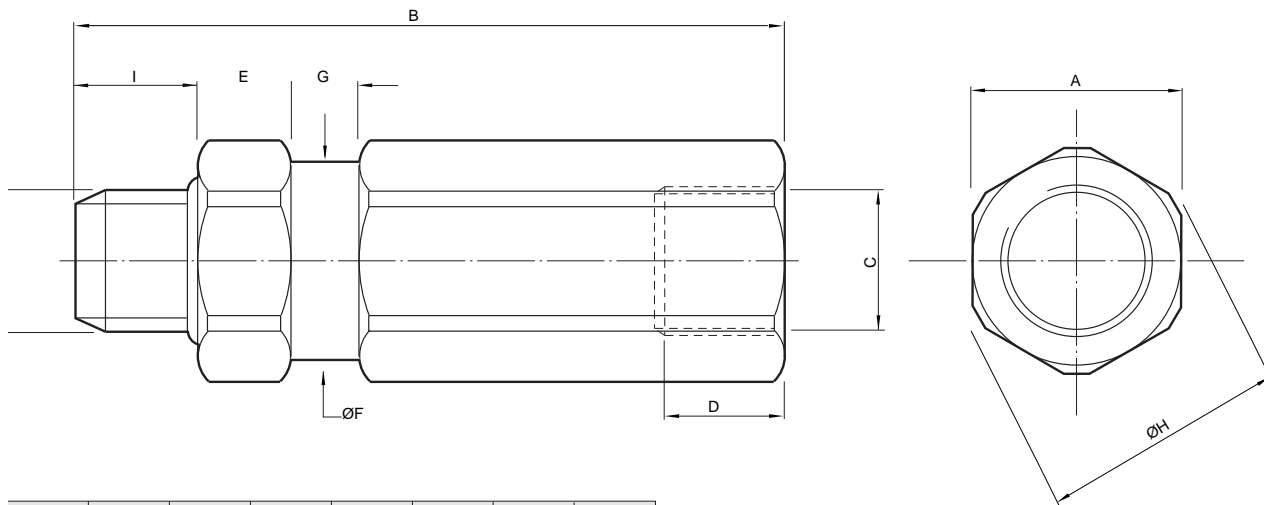

Model	T56M0500	T56A1800	T56B1800	T56C1800	T56A2800	T56B2800	T56C2800
A	11	14	14	14	17	17	17
B	31.8	49	49	45	62.5	59	56.2
C	M5	1/8	1/8	1/8	1/4	1/4	1/4
D	5	-	-	7	-	-	10.5
E	4	4.5	4.5	4.5	5.2	5.2	5.2
F	10.7	13.7	13.7	13.7	16.7	16.7	16.7
G	3	4	4	4	5	5	5
H	12	15	15	15	18.5	18.5	18.5
I	4.3	9.5	9.5	5.5	14.3	11	8

Warning

These products are intended for use in industrial compressed air systems only. Do not use these products where pressures and temperatures can exceed those listed under 'Technical Data'.

Before using these products with fluids other than those specified, for non-industrial applications, life-support systems, or other applications not within published specifications, consult Norgren.

Through misuse, age, or malfunction, components used in fluid power systems can fail in various modes. The system designer is warned to consider the failure modes of all component parts used in fluid power systems and to provide adequate safeguards to prevent personal injury or damage to equipment in the event of such failure.

System designers must provide a warning to end users in the system instructional manual if protection against a failure mode cannot be adequately provided.

System designers and end users are cautioned to review specific warnings found in instruction sheets packed and shipped with these products where applicable.